

Kit 3034

- VOLKSWAGEN California (T5)**, 4-dr Bus, 03-09, 10-
- VOLKSWAGEN Caravelle (T5)**, 4-dr Bus, 03-09, 10-
- VOLKSWAGEN Multivan (T5)**, 4-dr Bus, 03-09, 10-
- VOLKSWAGEN Shuttle (T5)**, 4-dr Bus, 003-09, 10-
- VOLKSWAGEN Transporter (T5)**, 2-dr Single Cab, 03-09, 10-
- VOLKSWAGEN Transporter (T5)**, 4-dr Double Cab, 03-09, 10-
- VOLKSWAGEN Transporter (T5)**, 4-dr Van, 03-09, 10-

This Kit is only for vehicles with fixpoint mounting or T-profile.

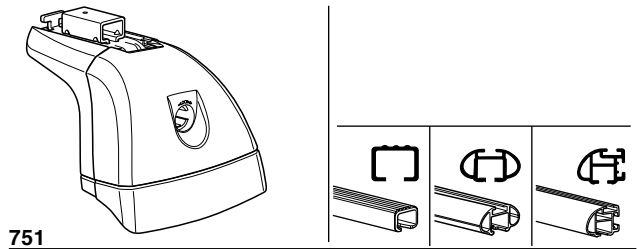

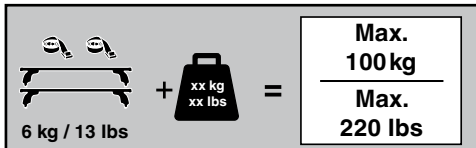

6 kg / 13 lbs + xx kg xx lbs = **Max. 100 kg**
Max. 220 lbs

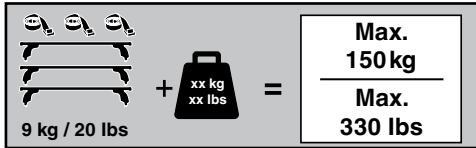

9 kg / 20 lbs + xx kg xx lbs = **Max. 150 kg**
Max. 330 lbs

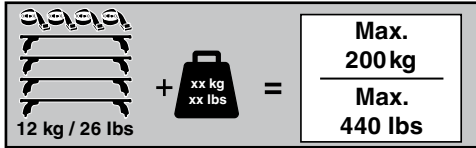

12 kg / 26 lbs + xx kg xx lbs = **Max. 200 kg**
Max. 440 lbs

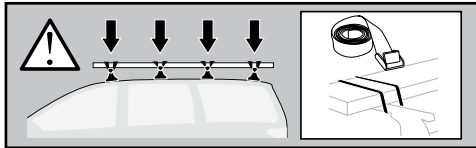
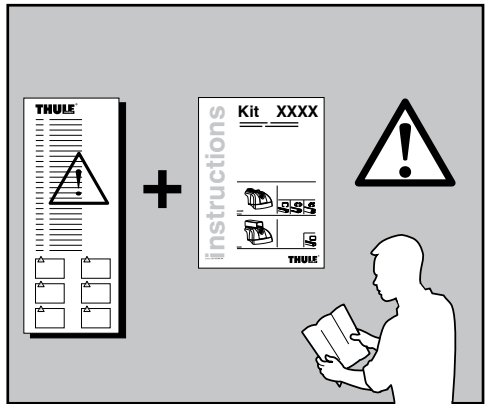
THULE + Kit XXXX + **!**

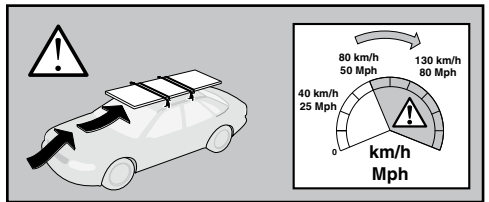

!

80 km/h 130 km/h
50 Mph 80 Mph

40 km/h 25 Mph

0 km/h Mph

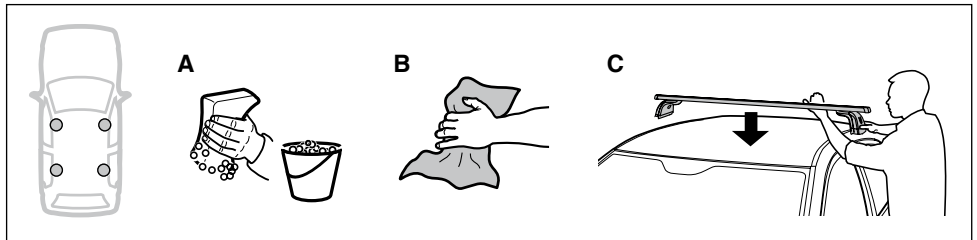

A **B** **C**

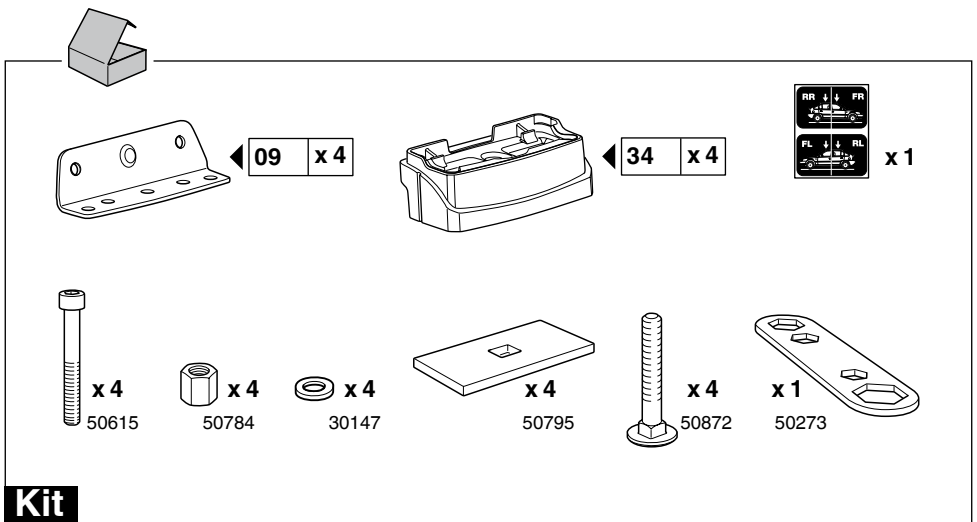

Kit

09 x 4

34 x 4

RR ↓ ↓ FR
FR ↓ ↓ RR

FL ↓ ↓ PL
PL ↓ ↓ FL

x 1

x 4 50615

x 4 50784

x 4 30147

x 4 50795

x 4 50872

x 1 50273

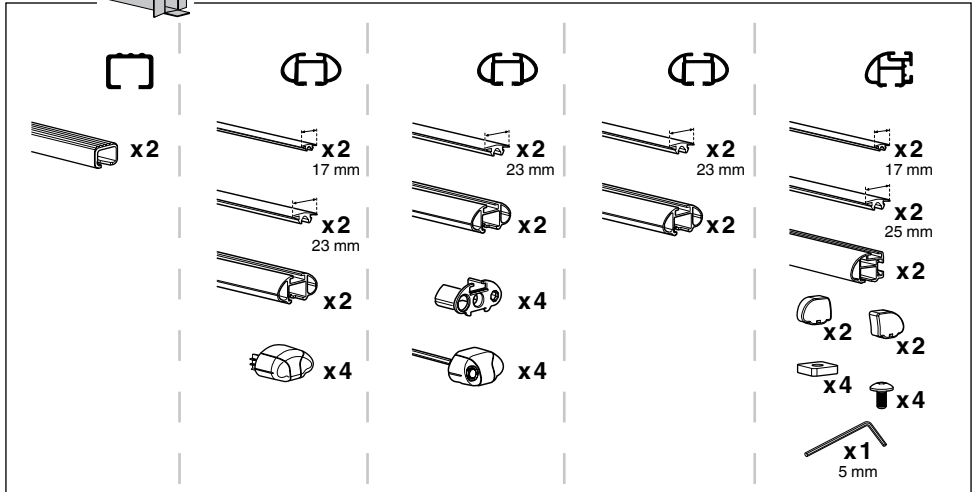
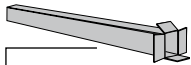
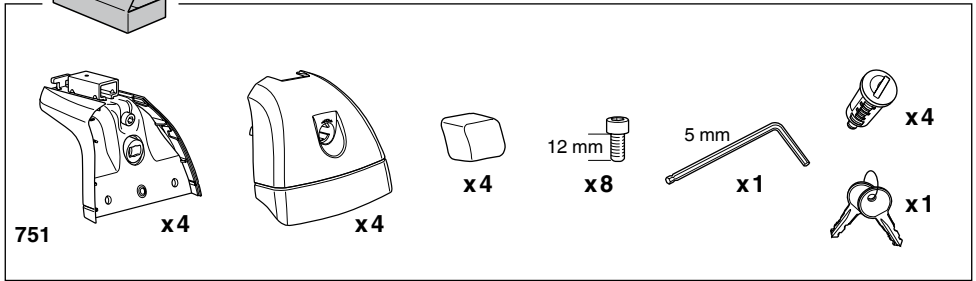
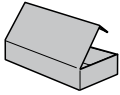

1

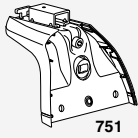

751

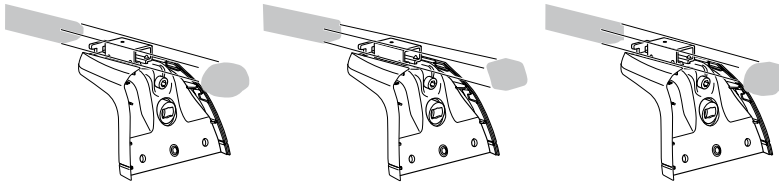

x4

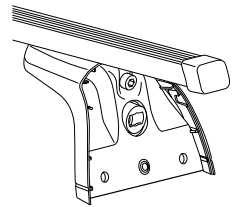
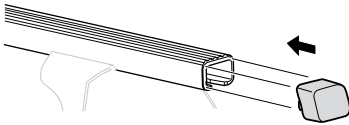

x4

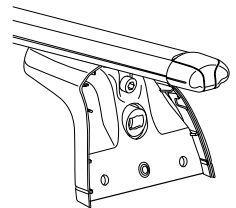
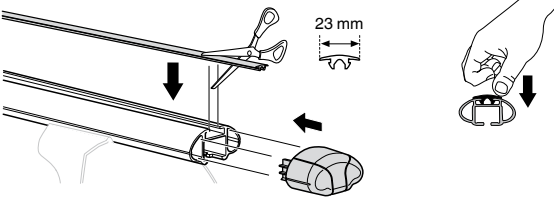

x4

x4

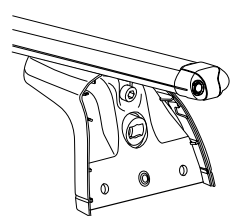
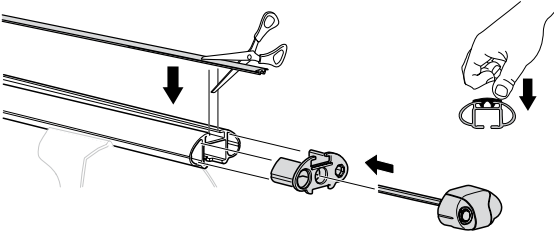

x2

x2

x4

x4

x1

5 mm

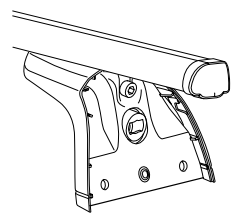
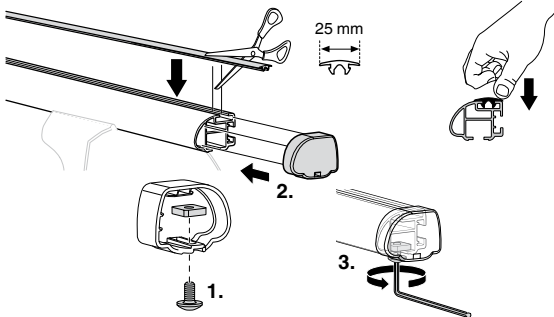

2

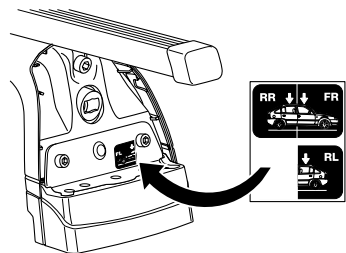
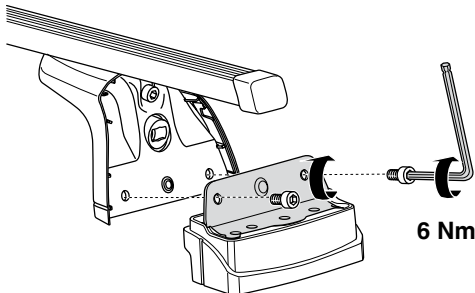
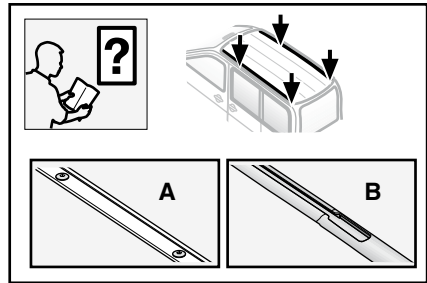
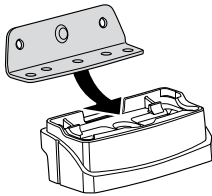
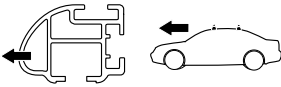
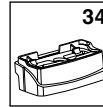
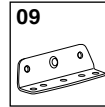
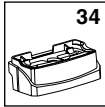
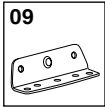
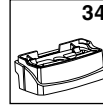
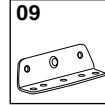
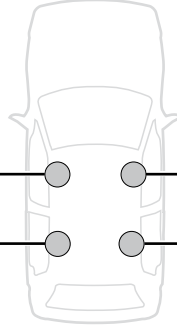
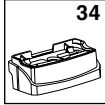
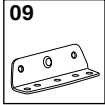
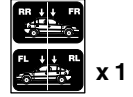
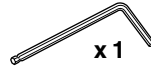
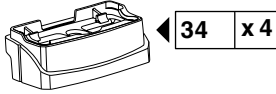
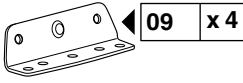

3



x4



x4

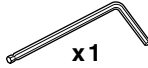

x1

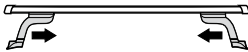
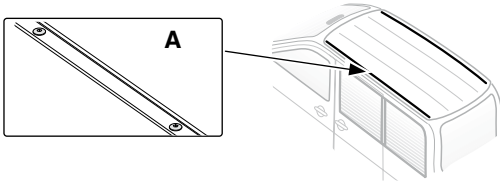
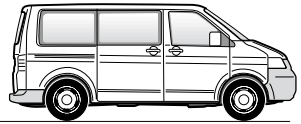
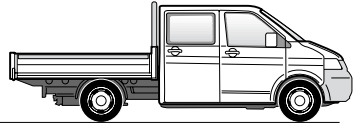
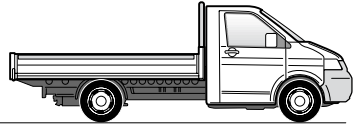

A

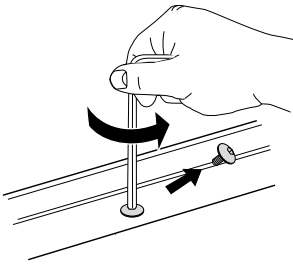

B

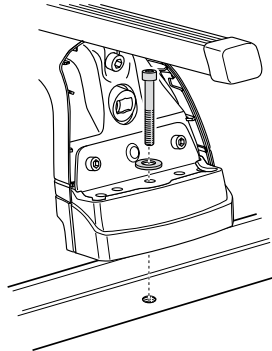

C

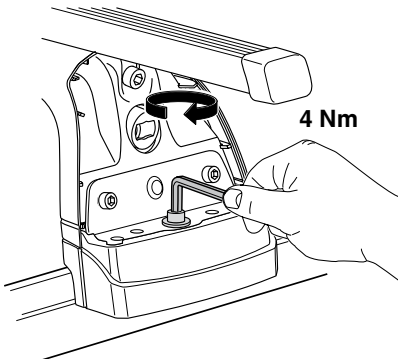

D

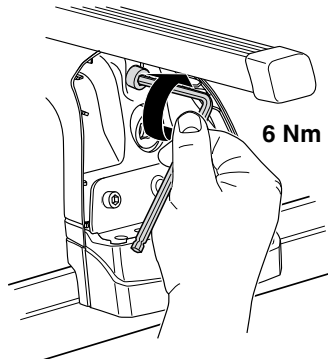

3

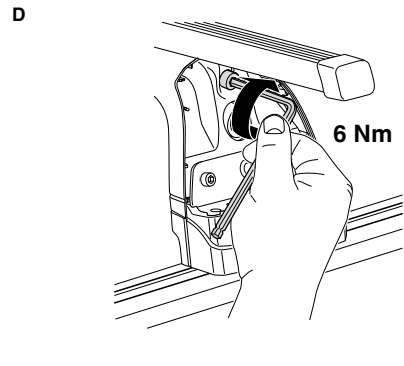
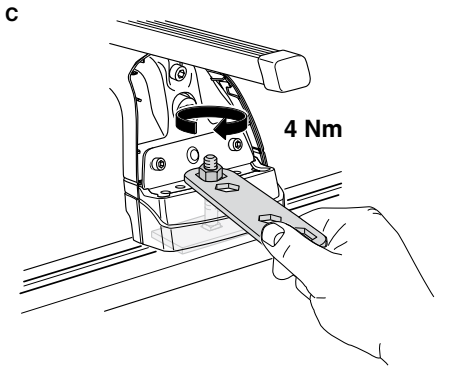
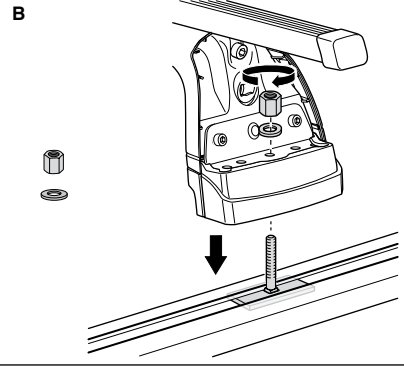
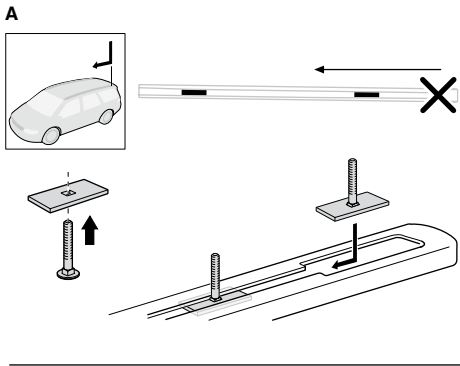
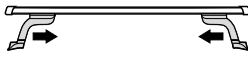
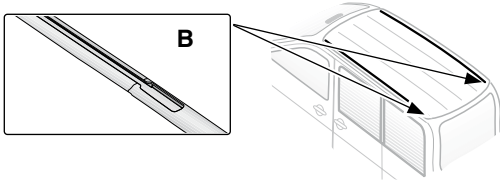
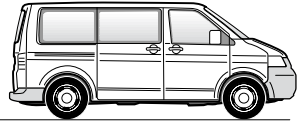
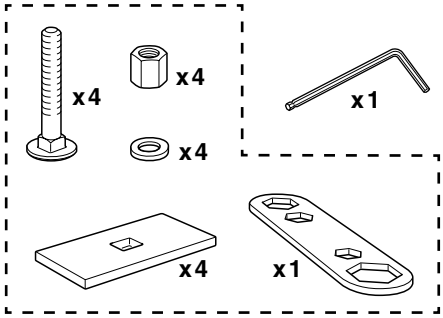

4

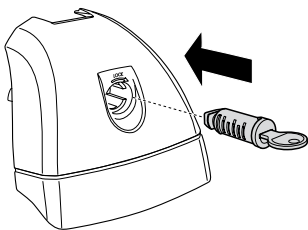

5

5 mm

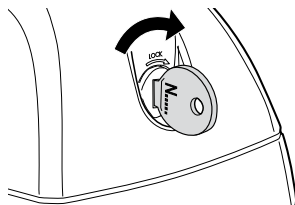
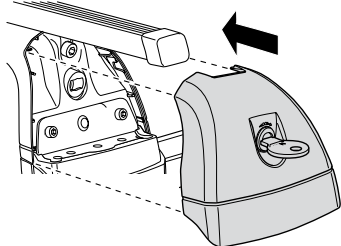
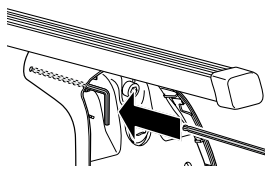

6

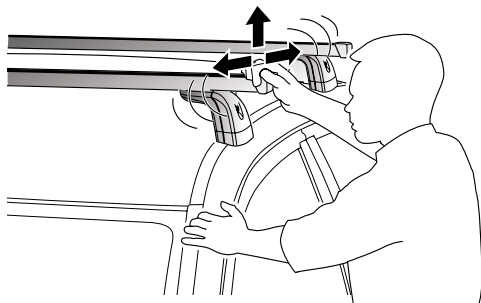

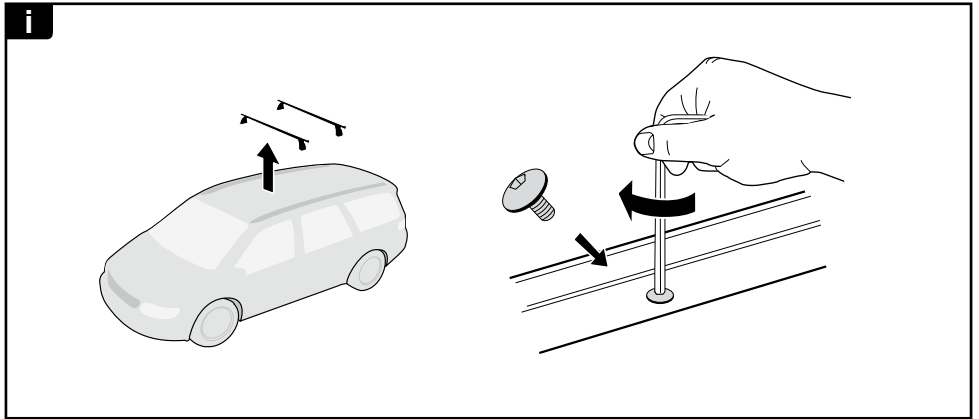
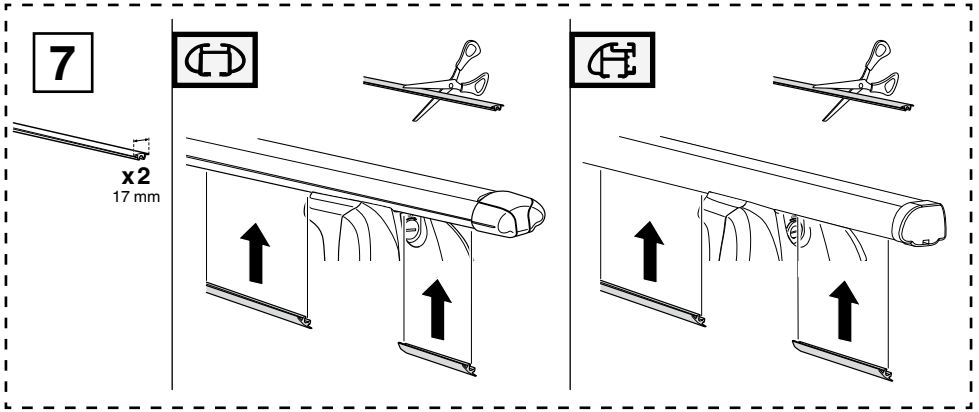

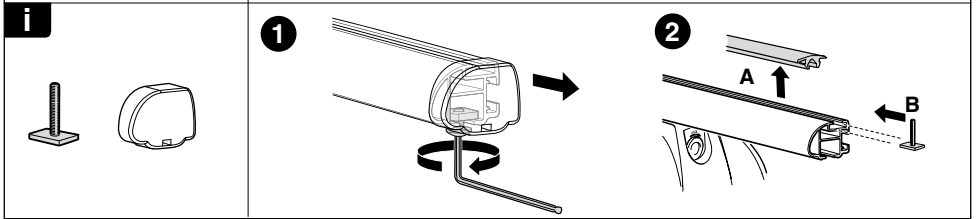
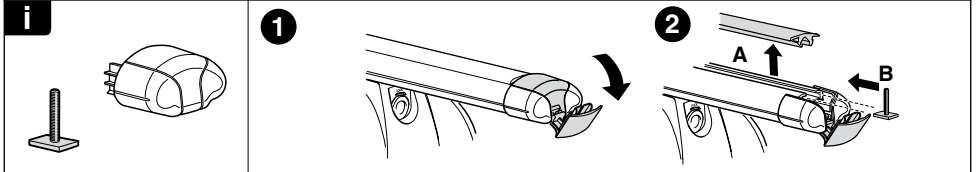
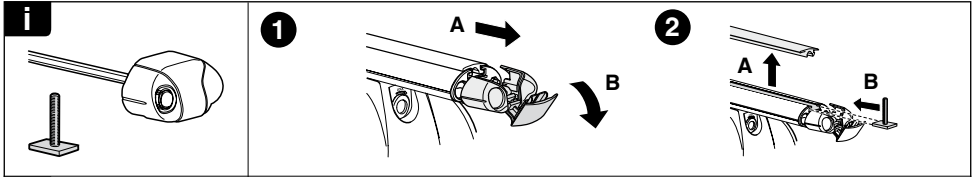
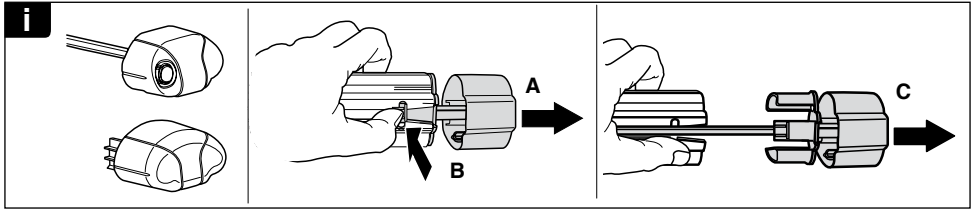

THULE
SWEDEN
**ONE
KEY
SYSTEM**

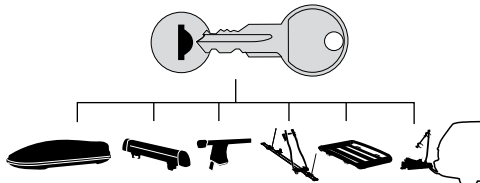

- 544 (x4)
- 596 (x6)
- 588 (x8)
- NA 510 (x10)
- EUR 452 (x12)
- ASIA

WW ▶ Thule Sweden AB, Box 69, 330 33 Hillerstorp, SWEDEN
 NA ▶ Thule Inc., 42 Silvermine Road, Seymour, Connecticut 06483, USA

info@thule.com
 customer.service@thule.com

www.thule.com
 506-3034